

### 10.7 Cutoff Length Recommended

Ra (μm)	Rz (μm)	Cutoff length (mm)
> 5~10	> 20~40	2.5
> 2.5~5	> 10~20	
> 1.25~2.5	> 6.3~10	0.8
> 0.63~1.25	> 3.2~6.3	
> 0.32~0.63	> 1.6~3.2	
> 0.25~0.32	> 1.25~1.6	0.25
> 0.20~0.25 > 0.16~0.20	> 1.0~1.25 > 0.8~1.0	
> 0.125~0.16 > 0.1~0.125 > 0.08~0.1	> 0.63~0.8 > 0.5~0.63 > 0.4~0.5	
> 0.063~0.08 > 0.05~0.063 > 0.04~0.05	> 0.32~0.4 > 0.25~0.32 > 0.2~0.25	
> 0.032~0.04 > 0.025~0.032 > 0.02~0.025	> 0.16~0.2 > 0.125~0.16 > 0.1~0.125	

15

## SURFACE ROUGHNESS TESTER

This Surface Roughness Tester is small in size, light in weight, easy to carry. Although complex and advanced, it is convenient to use and operate. Its ruggedness will allow many years of use if proper operating techniques are followed. Please read the following instructions carefully and always keep this manual within easy reach.

### 10.3.1 RC Filter

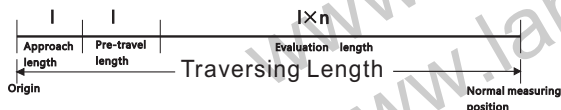

### 10.3.2 PC-RC Filter

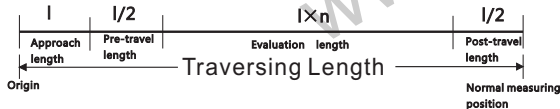

### 10.3.3 GAUSS Filter

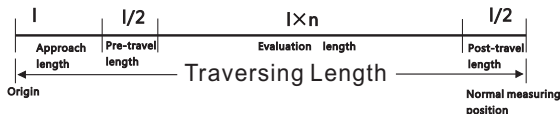

### 10.3.4 D-P Filter

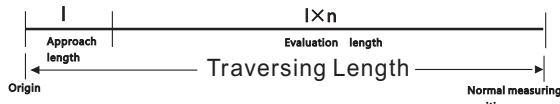

## 10.4 Definition of roughness parameter

### 10.4.1 Ra arithmetical mean deviation of profile

Arithmetic value of mean deviation of profile within sampling length.

$$Ra = \frac{1}{n} \sum_{i=1}^n |y_i|$$

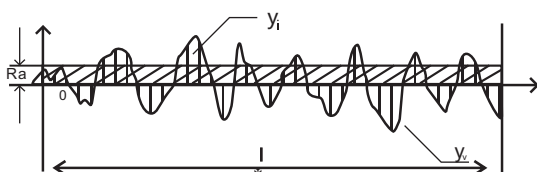

13

## 2 . Specifications

Display: LCD, with blue backlight

Parameters: Ra, Rz, Rq, Rt

### Display Range:

Ra=0.005~16um/0.020~629.9uinch

Rq=0.005~16um/0.020~629.9uinch

Rt=0.020~160.0um/0.780~6299uinch

Rz=0.020~160.0um/0.780~6299uinch

Accuracy: Not more than ±10%

Fluctuation of display value: Not more than 6%

### Sensor :

Test Principle: Inductance type

Radius of Probe Pin: 5um

Material of Probe Pin: Diamond

Measurement Force of Probe: 4mN(0.4gf)

Probe Angle: 90°

Vertical Radius of Guiding Head: 48mm

Maximum driving stroke: 17.5mm/0.7inch

Cutoff length (l): 0.25mm / 0.8mm / 2.5mm

### Driving speed:

Vt=0.135mm/s if sampling length = 0.25mm

Vt=0.5mm/s if sampling length = 0.8mm

Vt=1mm/s if sampling length = 2.5mm

Vt=1mm/s if returning

### Profile digital filter

Filtered Profile: RC

Filtered Profile: PC-RC

Filtered Profile: Gauss

Non-Filtered Profile: D-P

Resolution: 0.001μm if reading < 10μm

0.01μm if 10μm ≤ reading < 100μm

0.1μm if reading ≥ 100μm

Evaluation length : ( 1~5) cut-off optional

Operating conditions: Temp. 0~50°C

Humidity <80%

Power supply: 4x1.5AAA batteries

Size: Main Unit: 149x67x29 mm

2

## 1.Features

This instrument is compatible with four standards of ISO, DIN, ANSI and JIS and is widely used in production site to measure surface roughness of various machinery-processed parts, calculate corresponding parameters according to selected measuring conditions and clearly display all measurement parameters. When measuring the roughness of a surface, the sensor is placed on the surface and then uniformly slides along the surface by driving the mechanism inside the tester. The sensor gets the surface roughness by the sharp built-in probe. This roughness causes displacement of the probe which results in change of inductive amount of induction coils so as to generate analogue signal, which is in proportion to the surface roughness at output end of phase-sensitive rectifier. The exclusive DSP processes and calculates and then outputs the measurement results on LCD.

- \* Multiple parameter measurement: Ra, Rz, Rq, Rt
- \* Four wave filtering methods : RC, PC-RC, GAUSS and D-P
- \* Can communicate with PC computer for statistics, printing and analysing by the optional cable and the software for RS232C interface.
- \* Manual or automatic shut down. The tester can be switched off by pressing the Power key at any time. On the other hand, the tester will power itself off about 5 minutes after the last key operation.
- \* The tester can memorize 7 groups of measurement results and measuring conditions for later use or download to PC for analysing, printing.
- \* Metric /Imperial Conversion

1

Sensor: 185x56x47mm

Weight: 485g(Not including batteries)

### Standard Accessories:

Main unit  
Screwdriver  
Measuring base  
Adjustable stand  
Standard sensor  
Standard sample plate  
Sheath of sensor  
Carrying case  
Operation manual

### Optional accessories:

Cable & software for RS232C  
Groove stylus  
Curvature Probe  
Extension rod  
Measurement support  
Bluetooth interface

## 3.Front Panel Descriptions And Names Of Each Parts

### 3.1Key descriptions

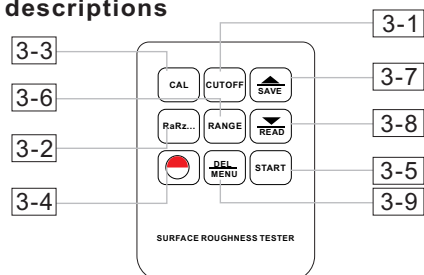

Fig. 3-1

- |                     |           |                 |
|---------------------|-----------|-----------------|
| 3-1 Cutoff          | 3-4 Power | 3-7 Up/Save     |
| 3-2 Parameter       | 3-5 Start | 3-8 Down/Read   |
| 3-3 Calibration key | 3-6 Range | 3-9 Delete/Menu |

3

## 10.4.2 Rz ten point height of irregularities

The average of the sum of five maximum profile peaks and the average of five maximum profile valleys within the sampling length.

$$R_z = \frac{\sum_{i=1}^5 \frac{1}{2} + \sum_{i=1}^5 y_v}{5}$$

## 10.4.3 Rq root-mean-square deviation of profile

Root-mean-square of profile deviation within the sampling length, shown as the following function

$$R_q = \left( \frac{1}{n} \sum_{i=1}^n \frac{1}{2} \right)^{\frac{1}{2}}$$

## 10.4.4 Rt total peak-to-valley height

Rt is the sum of maximum height of the profile peak and maximum depth of the profile valley for the evaluation length.

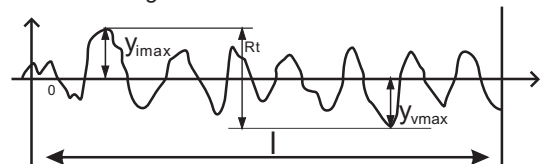

## 10.5Fault Information

- Err1 no data stored for browsing.
- Err2 the Ra value of the standard sample is too small to be uses for calibration.
- Err3 the value is too small to continue to decrease.

## 10.6Code Standard Name

ISO4287	International Standard
DIN4786	German Standard
JISB601	Japanese Industrial Standard
ANSIB46.1	American Standard

14

## 8. Communicate With PC

- 8.1 Install the optional RS232C software to the PC.
- 8.2 Connect the tester to the COM port of the PC with the optional RS232 cable.
- 8.3 Run the software on the desktop and select the COM port in the system settings.
- 8.4 Click the button of data collection, then click the button of Begin/Continue.
- 8.5 To download the groups stored in the Memory, just press the key

## 9. General Maintenance

- \* Avoid crashes, intensive vibration, heavy dust, humidity, grease stains and strong magnetic fields;
- \* The sensor is a precise part and should be protected carefully. It is recommended to put it back in the box after each operation;
- \* Protect the standard sample plate belonging to the instrument carefully to avoid calibration faults caused by scratches.

## 10.References

### 10.1 Filter

- A.RC filter: traditional 2-stage filter with phase difference;
- B.PC-RC filter: RC filter with phase-correction;
- C.Gauss filter: DIN4777
- D. D-P non-filtered profile: adopt central line of Least Square Algorithm

### 10.2Central Line

This tester adopts minimum central line of least square algorithm.

### 10.3Traversing Length

- l=sampling length
- n=number of sampling length
- lxn=evaluation length

12

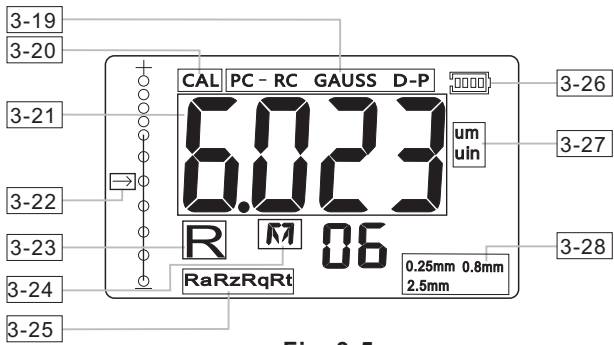

Fig. 3-5

- |                       |                 |
|-----------------------|-----------------|
| 3-19 Filter           | 3-24 Memory     |
| 3-20 Calibration      | 3-25 Parameters |
| 3-21 Measurement      | 3-26 Battery    |
| 3-22 Position pointer | 3-27 Unit       |
| 3-23 Browsing         | 3-28 Cutoff     |

### 3.3 Installation and unloading of sensor

To install, hold the main part of the sensor by hand, push it into connection sheath at the bottom of the instrument as shown in Figure 3-4 and then slightly push to the end of sheath. To unload, hold the main part of sensor or the root of protective sheath and slowly pull it out.

A. The probe of the sensor is the main part of this instrument and requires close attention.

B. During installation and unloading, the probe should not be touched in order to avoid damage which can affect measurement results.

C. Connection of the sensor should be reliable during installation.

5

## 4. Measuring Procedures

### 4.1 Preparations for measurement

A. Switch on to test if the battery voltage is normal.

B. The instrument automatically restores conditions of the last measurement before it is turned off since these conditions are automatically stored. Meanwhile, the second line of 2 digits on display shows the groups stored in the memory. Before taking measurement, preparations have to be made and checked.

C. To check if the cutoff length selected is right. If not, Depress the  $\left[ \text{CUTOFF} \right]$  to select. For the recommended cutoff length, please see the table in 10.7 on page 15.

D. To check if the evaluation length selected is right. If not, depress the key  $\left[ \text{RANGE} \right]$ , then  $\left[ \text{SAVE} \right]$  or  $\left[ \text{READ} \right]$  to select. To save and quit, just depress the key  $\left[ \text{RANGE} \right]$  again.

E. To check if the profile filter selected is right. If not, Depressing the  $\left[ \text{FIL M} \right]$  And not releasing it till 'FIL T' on Display. It takes about 4 seconds from starting pressing the  $\left[ \text{FIL M} \right]$ . And then pressing key  $\left[ \text{SAVE} \right]$  or  $\left[ \text{READ} \right]$  key to cycle between RC, PC-RC, GAUSS, D-P or vice versa. To quit, just press any key other than  $\left[ \text{SAVE} \right]$  key or  $\left[ \text{READ} \right]$  key.

F. To check if the measurement unit selected is right. If not, depressing the key  $\left[ \text{UNIT} \right]$  and not releasing it till 'UNIT' on the Display. It takes about 8 seconds from starting depressing key  $\left[ \text{UNIT} \right]$ . And then pressing  $\left[ \text{SAVE} \right]$  or  $\left[ \text{READ} \right]$  to switch between the metric system and the British system. To quit, just press any key other than  $\left[ \text{SAVE} \right]$  key or  $\left[ \text{READ} \right]$  key.

G. To check if the parameter selected is right. If not, depress the key  $\left[ \text{RaRz} \right]$  to select. This step is very important.

H. To clear the surface of the part to be measured;

I. Refer to Figure 4-1 and Figure 4-2 to place the instrument correctly, stably and reliably on the surface to be measured.

J. Refer to Figure 4-2, the sliding trail of the sensor must be vertical to the direction of process line of the measured surface.

K. Adjustable leg and sheath of sensor When the measured surface of the part is smaller than the measured surface of

7

## 4.2 Measuring

After preparations is done, just press Start key to measure if measuring conditions are not to be changed. Firstly, you will see the '\_\_\_' on the display and the probe is moving forward and sampling. Then you will see the probe stop sliding and move backward. The measurement result shows on the display after the probe stop moving.

### 4.2.1 Save the measurement results to the tester for later use.

After measuring, you will see the original 'M' becomes the 'M'. In such a state, you can save this group of results including Ra, Rz, Rq, Rt and measurement conditions to the memory of the tester by depressing the key  $\left[ \text{SAVE} \right]$ . Then the symbol 'M' changes to 'M' automatically while the number of memorized groups increases 1.

### 4.2.2 How to browse the different parameters

In 'M' state, you can browse different parameters. The corresponding parameter and its value show on the display once depressing the key

### 4.2.3 Delete the measurement results

In 'M' state, you can delete this group of results by depressing the key  $\left[ \text{DEL M} \right]$ . Then the symbol 'M' changes to 'M' automatically. On the other hand, the new measurement results will replace the old ones if pressing the Start key in 'M' state.

### 5. How to browse the memorized data

No matter in 'M' state or 'M' state, you can browse the memorized data by depressing the key  $\left[ \text{READ} \right]$ . The browsing state is marked in 'R' on display. When in 'R' state, you can browse different groups by depressing the key  $\left[ \text{SAVE} \right]$  or key  $\left[ \text{READ} \right]$ . The serial number of the group shows on the display. For each group, you can still browse different parameters. The corresponding parameter and its value show on the display once depressing the key  $\left[ \text{RaRz} \right]$ .

10

the part is smaller than the bottom surface of the instrument, the sheath of sensor and adjustable leg can be used for auxiliary support to complete measurement. (as shown in Figure 4-3)

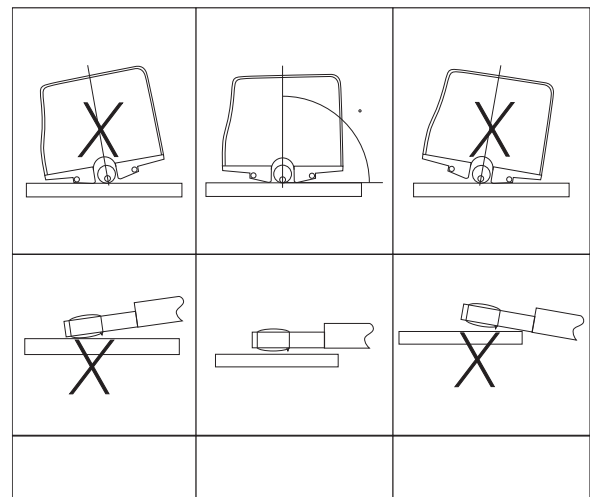

Fig.4-1

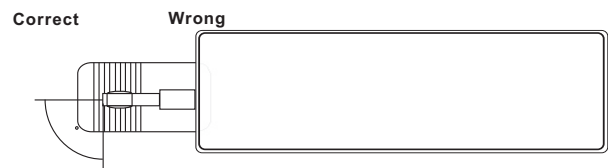

Fig.4-2

8

## 6. How to calibrate the tester

- 6.1 To enter the calibration state, just depressing the key **[CAL]**, The calibration state is marked by 'CAL'.
- 6.2 Take a measurement based on the Standard sample plate. Contrast the measuring value with the value of standard sample plate based on the same parameter.
- 6.3 Depress the key **[SAVE]** or **[READ]** to adjust the reading to the standard value.
- 6.4 Just repeat 6.2 to 6.3 till the accuracy is ok.
- 6.5 To quit, just press any key other than START key.
- 6.6 The instrument has been thoroughly tested before delivery to ensure that the display value error is less than  $\pm 10\%$ . The user is recommended not to use the Calibration function too often.

## 7. How to restore the factory settings

### 7.1 When to restore

It is necessary to restore the factory settings when a new probe is installed or the tester could not measure any more.

### 7.2 How to restore

7.2.1 Just depressing the key **[FAC]** and not releasing it till 'FAC' on the Display. It is about 16 seconds from starting depressing key **[FAC]**. This state is also marked by 'CAL', please see the Fig. 3-5.

7.2.2 press the START key on the Standard sample plate. During the probe moves forward, you will see the different reading on the display varying with the movement of the probe.

7.2.3 Use the screwdriver to adjust the resistance (3-35) and let the reading on the display close to the value of Standard sample plate.

7.2.4 Repeat 7.2.2 to 7.2.3 till the result is satisfactory.

The above procedures restore the factory settings.

7.2.5 After the factory settings, you have to calibrate the tester again. Please refer the part 6.

11

## 3.2 Names of each parts

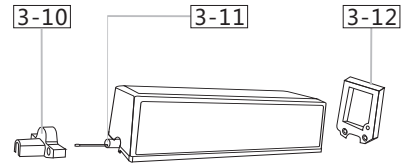

Fig. 3-2

- 3-10 Sheath of probe
- 3-11 Probe
- 3-12 Adjustable leg

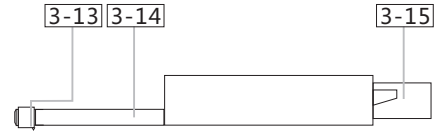

Fig. 3-3

- 3-13 Stylus
- 3-14 Protection sleeve
- 3-15 Socket

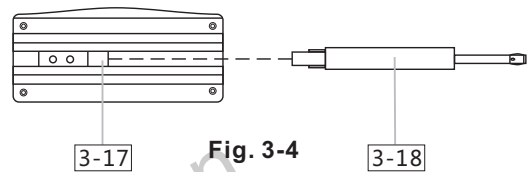

Fig. 3-4

- 3-17 Connection sheath
- 3-18 probe

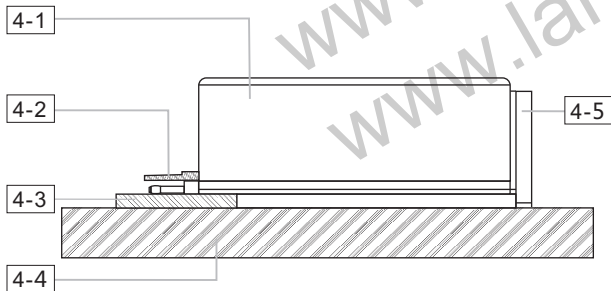

Fig.4-3

- 4-1 Roughness tester
- 4-2 Sheath of probe
- 4-3 Item to be measured
- 4-4 Working table
- 4-5 Adjustable leg

9

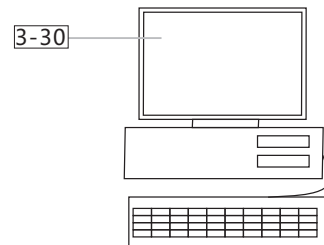
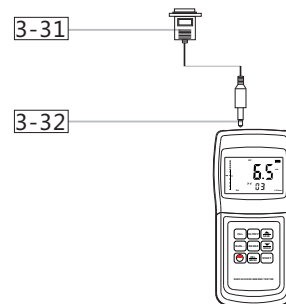

Fig.3-6

Connection of Power Adapter and RS232C



- 3-30 Computer
- 3-31 RS-232 port to PC COM
- 3-32 RS-232 socket

6