

# DIGITAL GAUSS METER INSTRUCTION

## GS-100DAH

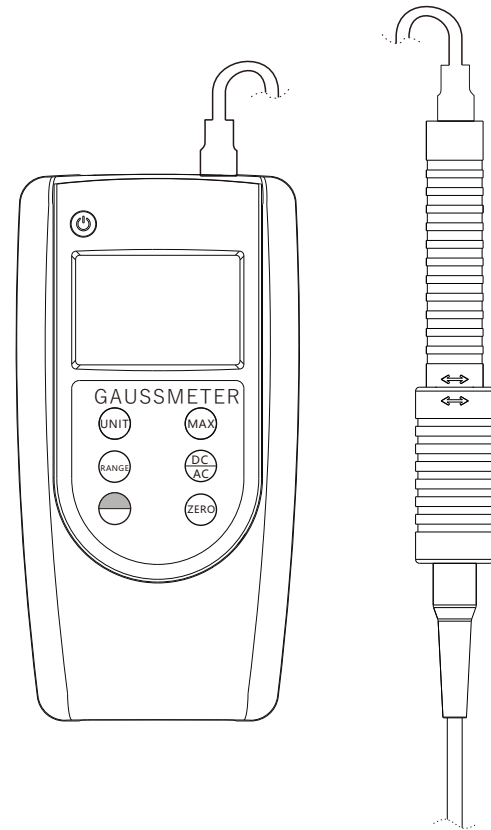

# OPERATION INSTRUCTION

Thank you for purchasing "GS" series digital Gauss meter. This manual briefly introduces the various functions of this machine, allowing you to operate freely, please read this manual carefully before using.

## An overview of

This instrument can be used to measure the DC magnetic field, AC magnetic field, radiation, magnetic field, magnetic remanence, earth magnetic field and so on all kinds of magnetic induction intensity. Gauss meter is a special instrument for measuring the magnetic induction intensity of magnets. It is one of the widely used measuring instruments in the field of magnetic measurement.

This instrument is a hand-held digital Gauss meter controlled by a single chip microcomputer, which can be used to measure the magnetic induction intensity of dc magnetic field, AC magnetic field, radiation magnetic field and other magnetic fields. The instrument can be carried on hand, wide range, easy to operate, liquid crystal display. There are measuring/peak holding, mT/Gs unit conversion, touch-tone automatic zero setting. 200mT/2000mT range conversion and other functions.

## Field of Practical work:

1. Magnetic field distribution in the surface space of permanent magnet materials (that is, the magnetic field of measurement scale, as we usually call it);
2. Interstitial magnetic field in magnetic circuit structure;
3. A magnetic field generated by a device used to absorb ferromagnetic materials (e.g., iron remover, magnetic separator, magnetic chuck, electromagnet) by a permanent magnet or ac-DC current. Demagnetization device);
4. Environmental magnetic field (including geomagnetic field and residual weak magnetic field of ferromagnetic materials);

## Two Working Principles

This series of instruments is based on the Hall effect principle made of sensors, namely hall sensors. There are two kinds of sensors, transverse and axial. Users can choose or match them according to their needs. The circuit uses low drift amplifier and high stability power supply, controlled by single chip microcomputer, 4<sup>1</sup>/<sub>2</sub> LCD display time value.

## Three Hall effect principle

A metal or semiconductor wafer placed in a magnetic field produces an electromotive force in the direction perpendicular to the current and magnetic field when an electric current flows through it. This physical phenomenon is called the Hall effect.

Hall effect principle is the essence of the material of the solid carrier in additional magnetic field (B) perpendicular to the solid material in the movement, due to the effect of Lorentz force ( $F_B$ ) and offset in the trajectory, and the material on both sides of (3.4) to produce electric charge accumulation in vertical direction of the electric and magnetic field direction of the electric field, eventually make the current-carrying to the Lorentz force and electric repulsion is flat ( $F_B = F_e$ ) and on the two sides established a stable electric potential difference is the Hall voltage ( $V_H$ ). The basic relation is  $V_H = K_h I_h B$

## Among them:

- $I_h$ : Working current
- $B$ : Flux density
- $K_h$ : Component sensitivity
- $V_h$ : Hall voltage

## Usage of sensors

Take transverse sensors, for example

1. Sensor measurement method  
The line of force of the magnetic field under test crosses vertically Hall element at the front of the sensor (pictured right)

**Note:** The hall plate should be connected with the measured magnetic field when measuring. The lines of magnetic force are placed vertically

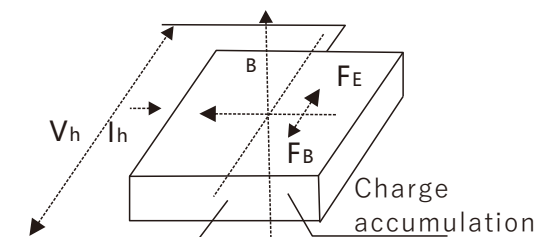

Hall effect schematic

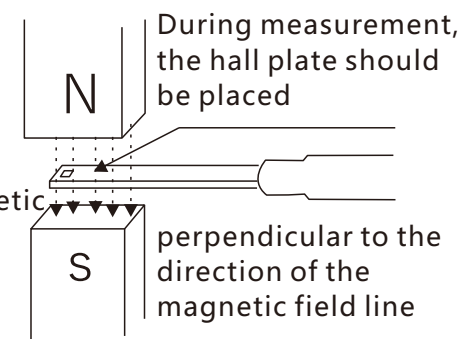

2. The diagram and description of the magnetic field measured by the handheld sensor are shown in FIG. 1-1. Use the end of the hall element at the front end of the sensor to lightly touch the surface of the magnet being measured or the position of the spatial magnetic field being measured at a position of 2.3mm. (**Note:** the non-graduated side of the probe is attached to the measured object, while the metal probe is attached to the non-polka-dot side)



图 1-1



图 1-2

#### Iv. Appearance description

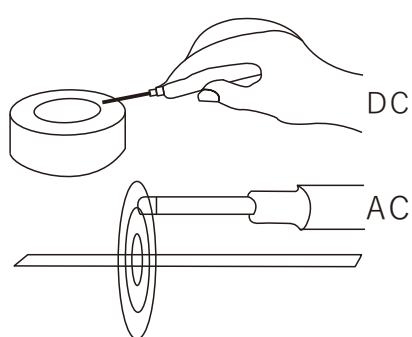

图 2-1

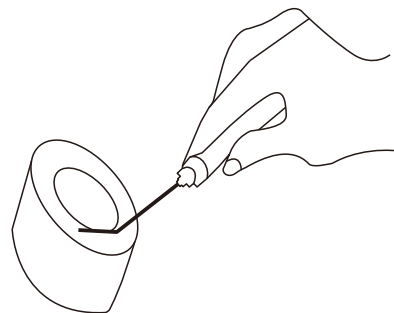
- 2-1 ON/OFF
- 2-2 UNIT
- 2-3 RANGE
- 2-4 ON/OFF
- 2-5 MAX
- 2-6 DC/AC
- 2-7 ZERO

#### Liquid crystal display

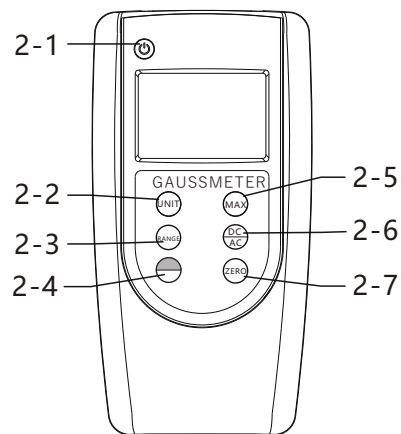
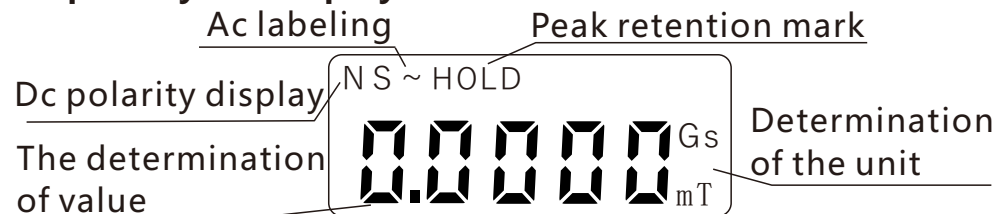

#### Main technical indicators

1. Range: 0~200mT, 2000mT
2. Frequency range:1-400HZ
3. Accuracy:DC,1%/AC,1%,1-400HZ (measured in uniform magnetic field)
- Resolution: DCX1:0.00~200.00mT 0.01mT  
DCX10:0.0 ~ 2000.0 mT 0.1 mT  
ACX1:0.00 ~200.00mT 0.01mT  
ACX10: 0.0 ~ 2000.0mT 0.1mT
5. Measured magnetic field: DC magnetic field (static magnetic field)  
Ac magnetic field (dynamic magnetic field)
6. Function description: Peak retention function  
Gs (Gauss) /mT (Millitesla) can be switched freely
7. N/S polarity display during DC measurement.N for positive and S for negative
8. Display button will automatically adjust zero quickly
9. Ambient temperature: 5°C~ 40°C
10. Relative humidity: 20%~ 80% (no condensation)
11. Power supply: 4x1.5v AAA (UM-4) Battery

- 12. Size: 140mm (L) X73mm (W) X 30mm (H)
- 13. Instrument weight: 180g
- 14. Display mode: 4<sup>1</sup>/<sub>2</sub> LCD
- 15. Display unit: mT/Gs

**Six, operation steps**

1. Put the battery into the battery box behind the meter and then cover the battery cover plate; If the external power is used, plug one end of the external power into the power socket on the left side of the instrument and plug the end into a 220V socket.
2. Install sensors. Plug the Hall sensor into the sensor slot above the meter.

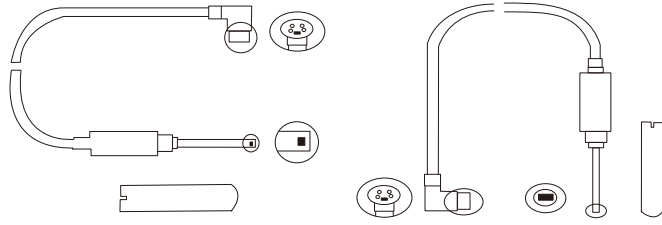

3. Press the "ON/OFF" button ON the panel, and the LCD will display as follows.

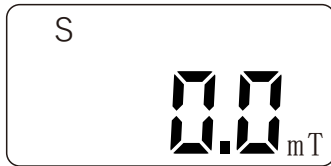

4. Select the range  
When the range conversion button is pressed repeatedly, the measurement range is between 0~200mT and 0~2000mT.



0~200mT

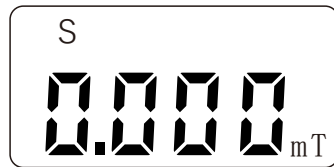

0~2000mT

5. Choose DC/AC  
When the DC/AC button is pressed repeatedly, the LCD screen will change alternately as shown below. Denotes the measurement of dc or AC magnetic fields. (In measuring the DC magnetic field, "N" or "S" indicates polarity)

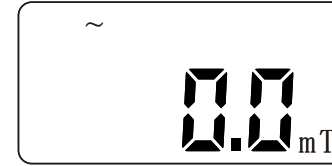

Ac magnetic field



Dc magnetic field

6. Select display unit  
When the display unit conversion button is pressed repeatedly, the display unit is converted between MT and GS.



mT



Gs

- 7, zero  
Keep the sensor away from the magnetic field in a non-maintained state. If the display is not 0, press the reset/reset peak button to make it zero.  
**Note:** if the measurement needs to be converted range or converted AC/DC, it must be reset to zero and then re-measured. Or zero it all out before you measure it.

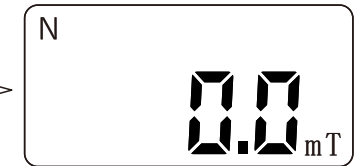

8. Select the peak retention function

When the peak hold measure button is pressed repeatedly, the normal measure or peak hold measure can be selected.

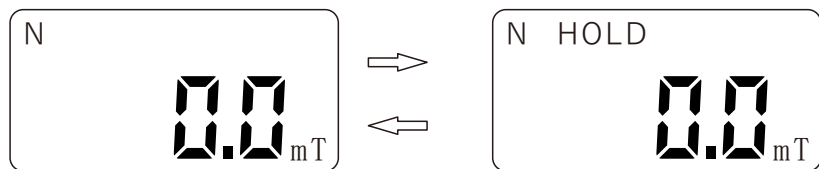

Common measurement      Peak retention measurement

1. measure

The hall sensor sheath is opened, and then the effective position (transverse sensor) or (longitudinal sensor) of the Hall sensor is in close contact with the material surface (DC magnetic field) or the position of the measured magnetic field (space AC and DC magnetic field) for measurement. The LIQUID crystal display is the size of the measured magnetic field.

2. Reset the peak to maintain

If the peak value needs to be re-measured during the measurement of peak retention state, and the peak value is expected to be smaller than the original peak value, the reset/peak Reset button can be pressed to re-read the peak value.

When the instrument enters the peak retention state, the data display will only change if there is a value larger than the current display value. If the measured data is smaller than the current display value, the display value will not change. So you have to reset it at the peak.

**Note:** This is still in the "peak measurement" state.

**Example:** the original peak value is 1500mT: when determining the new peak value, predict the new peak value & LT;1500 mt, 800 mt & gt;.

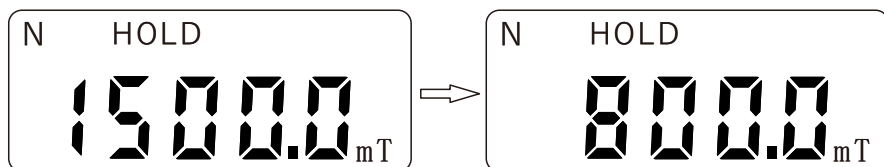

**Note:** After the instrument is tested, please insert the sheath on the sensor and preferably take out the battery.

**0. 1mT=1Gs**

**1mT=1000Gs**

**Packing list:**

1. One host machine
2. Hall sensor one
3. One copy of operation instruction